

# Instruction Manual



1.54 inch OLED Panel

(Suitable for water parking heater appliances)

|                      |                       |               |
|----------------------|-----------------------|---------------|
| 1.54 inch OLED panel |                       |               |
| 1                    | OLED display screen   |               |
| 2                    | 3                     | LED indicator |
| 4                    | Knob & Confirm button |               |
| 5                    | Set button            |               |
| 6                    | Back button           |               |

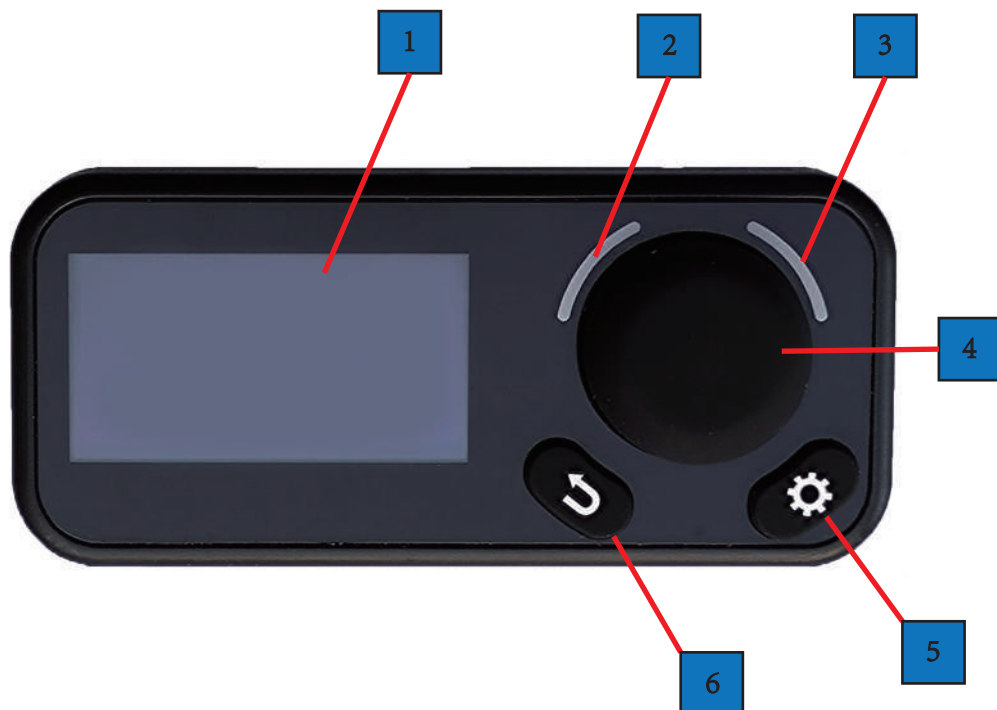

## 目录

### 1.DISPLAY

- 1.1 LEVEL ADJUSTMENGTT
- 1.2 HEATER STATE
- 1.3 WORK SETTINGS
- 1.4 SET WATER TEMPERATURE
- 1.5 DURATION TIME SETTING
- 1.6 TIMER SETTING

### 2.STANDBY AND TIME

### 3.SETTINGS

- 3.1 TIME SETTING
- 3.2 BLUETOOTH SETTINGS
- 3.3 SOUND SETTINGS
- 3.4 INFORMATION
- 3.5 LANGUAGE SETTINGS
- 3.6TEMPERATURE SCALE
- 3.7 FUEL PRIMING FUNCTION

### 4.COMMUNICATION AND FAULT

- 4.1 IN CONNECTION
- 4.2 NO CONNECTION
- 4.3 COMMUNICATION DISCONNECT
- 4.4 FAULT

### 5.LED INDICATOR

### 6.REMOTE CONTROL · BLUETOOTH · UPGRADES

- 6.1 REMOTE CONTROL
- 6.2 BLUETOOTH
- 6.3 UPGRADES

### 7.INSTALLATION

- 7.1 INSTALLATION LOCATION
- 7.2 INSTALLATION STEPS

# 1.DISPLAY









- After power-on, the panel enters the connecting state.
- After the connection is completed, the panel enters the working interface



(working interface)

## ● The screen display content

- 12:00:00 Icon → The current time is 12 o'clock, 0 minutes and 0 seconds.
-  Icon → Variable Heat mode
- P6** Icon → Current power level is P6
-  Icon → The heater is turned on
- 1:35 Icon → The remaining heating time is 1 hour and 35 minutes
-  Icon → Bluetooth is connected
-  Icon → in the process of remote control
-  Icon → The timer has been turned on
- 25 C Icon → Current water temperature

 → timer 2 is working



- 1.On the working interface, long press the confirm button to turn on or off the heater.
- 2.Long press: Press time >1.5 seconds
- 3.Short press: Press time <1.5 seconds

## 1.1 LEVEL ADJUSTMENT



- Power level range (P1-P6)
  - P1 is minimum power level
  - P6 is maximum power level
- Intensity Adjustment
  - Rotary knob

## 1.2 HEATER STATE



- **State**
  - The heater is turned on
- **Settings**
  - Short press confirm button to enter the mode settings
  - Long press the confirm button to turn off the heater



- **State**
  - The heater is Shutting Down.
  - (OFF Flashing)
- **Settings**
  - Short press confirm button to enter the mode settings
  - Long press the confirm button to turn on the heater
  - Short press back button to enter the time display



- **State**
  - The heater is turned off.
- **Settings**
  - Short press confirm button to enter the mode settings
  - Long press the confirm button to turn on the heater
  - Short press back button to enter the time display



1. Long press: Press time >1.5 seconds
2. Short press: Press time <1.5 seconds

## 1.3 WORK SETTINGS

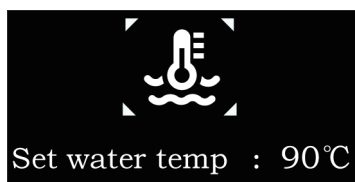

- **Enter the work settings**
  - Under the (working interface), Short press confirm button
- **Switching options**
  - Rotary knob
- **Enter the options**
  - Short press confirm button
- **Exit**
  - Short press back key

## 1.4 SET WATER TEMPERATURE

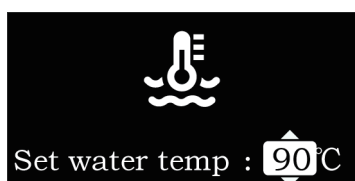
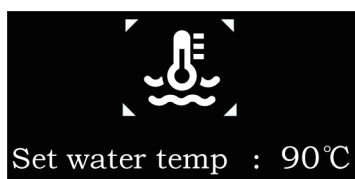

- **Entry water temperature setting**
  - Under (work settings), find the "set water temperature" setting option, and short press the confirm button again to enter
- **Water temperature setting range**
  - 35°C - 95°C
- **Confirm water temperature Settings**
  - Short press confirm button
- **Exit Water temperature setting**
  - Short press the back button



Note: water temperature Settings must be in the heater is valid during the work, If the heater is closed set water temperature, You need to start the heater after the setup is complete

## 1.5 DURATION TIME SETTING



### ● Enter the duration time setting

- Under (work settings), find the "duration time" setting option, and short press the confirm button again to enter.

**01:05** Icon → The duration time is 1 hour and 5 minutes

**∞** Icon → The duration time is ∞

(The maximum duration time setting is 24 hours, and the minimum time setting is 10 minutes.)

### ● Confirm the setting

- Short press confirm button

### ● Exit

- Short press back key



- After the heater is turned on, the timing starts, and after reaching the set time, the heater will be automatically turned off
- When the duration time is ∞, after reaching the set time, the heater will not be automatically turned off

## 1.6 TIMER SETTING



- **Enter the timer setting**
  - Short press the confirmation button on the working interface, find the timer setting option, and then short press the confirm button again to enter.

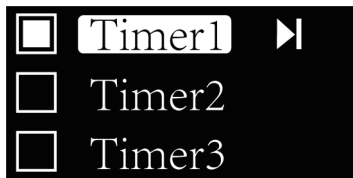

- **Turn on and off the timer**
  - Short press the confirm button at the position of the timer name
- Timer on state       → Timer off state
- **Switching options**
  - Rotary knob



- **Setting of timer parameters**
  - Short press the confirmation button at position ► to enter the parameter setting of the corresponding timer

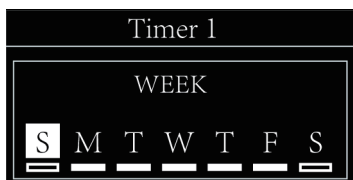

- **Setting of timer week**
  - Press the confirm button to turn on or turn off
- Week on state       → Week off state
- **Switching options**
  - Rotary knob
- **Exit**
  - Short press back key

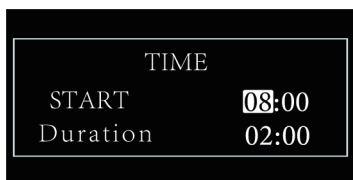

- **Timer time setting**
  - Short press confirm button
- 08:00 Icon → The starting time 8 hours and 0 minutes
- 02:00 Icon → The working duration is 8 hours and 0 minutes  
 (The working duration is up to 24 hours at most and 10 minutes at least.)
- **Exit**
  - Short press back key

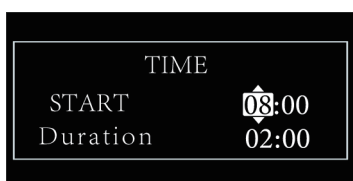

- **Confirmation of timer time setting**
  - Short press confirm button
- **Adjustment of timer time**
  - Rotary knob
- **Exit**
  - Short press back key



In order to ensure safety, the timer is turn off after the power is cut off

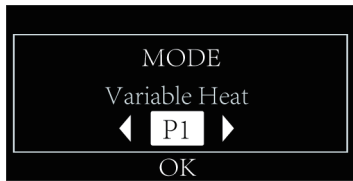
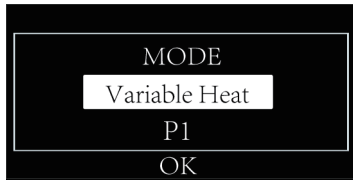

- **Timer level setting**
  - Short press confirm button
- **Timer level adjustment**
  - Rotary knob
- **Exit**
  - Short press back key

## 2 STANDBY AND TIME



- **State**
  - Standby (screen off)
- **Settings**
  - Press any key to exit standby mode

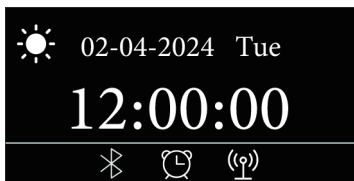

- **Current interface**
  - Time Display
- **Turn on and off standby mode**
  - Long press set button
- **Enter the working interface**
  - Short press back key
  - Short press confirm button

- ✕ Icon → Bluetooth is connected
- (Ⓜ) Icon → in the process of remote control
- 🕒 Icon → The timer has been turned on
- ☀️ Icon → Standby is turned off



After the heater is turned off and there is no operation within 20 seconds, the control panel will automatically switch to the time display. If the standby is turned on, it will enter the standby mode 20 seconds later



## 3.SYSTEM SETTINGS

- **Enter System Settings**
  - Short press set button
- **Switch Setting Options**
  - Rotary knob

- **Exit System Settings**
  - Short press back key

Attention: To ensure safety, when the heater is working, the control switch cannot enter the system settings.

### 3.1 TIME SETTING

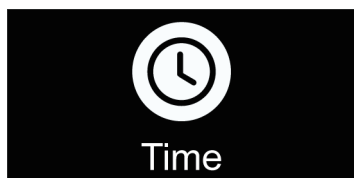

- **Current setting options**
  - Time Setting
- **Enter the time setting**
  - Short press confirm button
- **Switch setting options**
  - Rotary knob

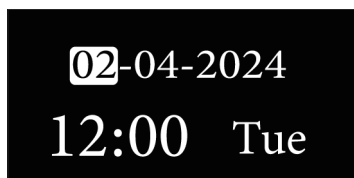

- **Time setting**
  - The time is displayed in 24-hour format
  - The time parameters that can be set include year, month, day, hour and minute.
- **Enter the time parameters settings**
  - Short press confirm button
- **Switch time parameters options**
  - Rotary knob

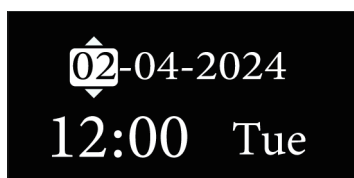

- **Time parameters settings**
  - "The day of the week" is automatically calculated and does not need to be set.
- **Confirm time parameters**
  - Short press confirm button
- **Time parameters adjustment**
  - Rotary knob
- **Exit time setting**
  - Short press the back button



When setting the time, the "seconds" do not appear on the interface.

When confirming the time parameter settings, the "seconds" will be reset to zero.

The time has no memory function, and when the power is cut off, the time will return to the default.

## 3.2 BLUETOOTH SETTINGS

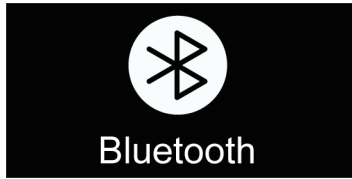

- **Current setting options**
  - Bluetooth Setting
- **Enter the bluetooth settings**
  - Short press confirm button
- **Switch setting options**
  - Rotary knob

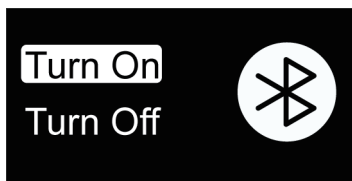

- **Current selection status**
  - ON
- **Confirm bluetooth settings**
  - Short press confirm button
- **Exit bluetooth settings**
  - Short press the back button



- **Current selection status**
  - OFF
- **Confirm bluetooth settings**
  - Short press confirm button
- **Exit bluetooth settings**
  - Short press the back button



Bluetooth Settings have memory function, will not change when the power is cut off

### 3.3 SOUND SETTINGS

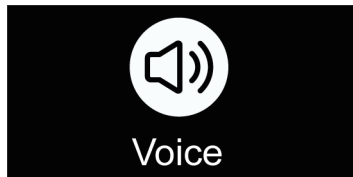

- **Current setting options**
  - Sound Settings
- **Enter sound Settings**
  - Short press confirm button
- **Switch setting options**
  - Rotary knob

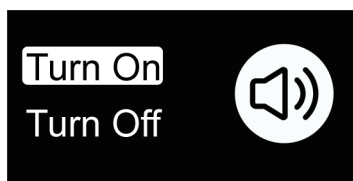

- **Current selection status**
  - ON
- **Confirm sound settings**
  - Short press confirm button
- **Exit sound settings**
  - Short press the back button



- **Current selection status**
  - OFF
- **Confirm sound settings**
  - Short press confirm button
- **Exit sound settings**
  - Short press the back button



Sound Settings have memory function, will not change when the power is cut off

## 3.4 INFORMATION



- **Current setting options**
  - Information
- **Enter information options**
  - Short press confirm button
- **Switch setting options**
  - Rotary knob



- **Current display**
  - select the information option
- **Switching information options**
  - Rotary knob
- **Enter the option**
  - Short press confirm button

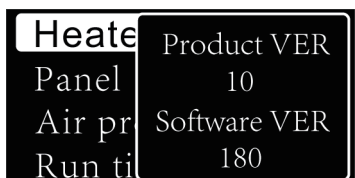

- **Current information display**
  - Heater information
- **Exit Heater information display**
  - Short press the back button
  - Short press confirm button



- **Current information display**
  - Control Panel Information
- **Exit control Panel Information display**
  - Short press the back button
  - Short press confirm button

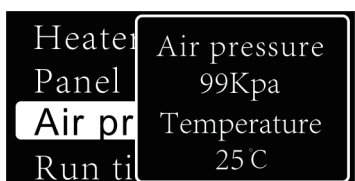

- **Current information display**
  - Atmospheric pressure information
- **Exit atmospheric pressure information display**
  - Short press the back button
  - Short press confirm button

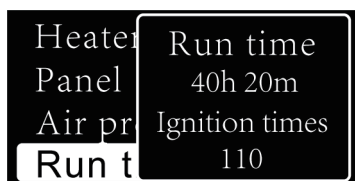

- **Current information display**
  - Heater information
- **Exit heater information display**
  - Short press the back button
  - Short press confirm button

(Figure 1)

## 3.5 LANGUAGE SETTINGS



- **Current setting options**
  - Language setting
- **Enter language settings**
  - Short press confirm button
- **Switch setting options**
  - Rotary knob



- **Current selected language**
  - Chinese
- **Confirm language settings**
  - Short press confirm button
- **Exit language settings**
  - Short press the back button



- **Current selected language**
  - English
- **Confirm language settings**
  - Short press confirm button
- **Exit language settings**
  - Short press the back button



Language Settings have memory function, will not change when the power is cut off

## 3.6 TEMPERATURE SCALE

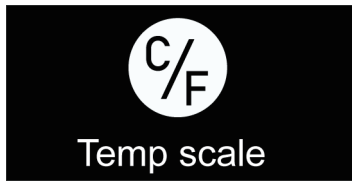

- **Current setting options**
  - Temperature scale setting
- **Enter temperature scale settings**
  - Short press confirm button
- **Switch setting options**
  - Rotary knob



- **Current selected temperature scale**
  - Centigrade
- **Confirm temperature scale settings**
  - Short press confirm button
- **Exit Temperature scale settings**
  - Short press the back button



- **Current selected temperature scale**
  - Fahrenheit
- **Confirm temperature scale settings**
  - Short press confirm button
- **Exit temperature scale settings**
  - Short press the back button



Temperature scale Settings have memory function, will not change when the power is cut off

## 3.7 FUEL PRIMING FUNCTION



(Figure 2)

- **Start:**

Under the "Figure 1" interface

1. Long press the Back and Set buttons
2. When it appears (**Figure 2**), press confirm

- **Exit**

- Short press the back button
- Automatically exit if it exceeds 3 seconds

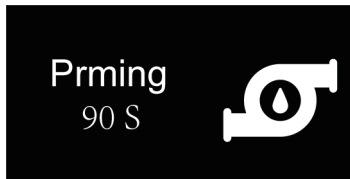

- **Current state**

- Priming

- **Time regulation**

- Rotary knob

- **Exit**

- Short press the back button
- Long press confirm button



Prime Fuel 90 seconds, the default time automatically quit the end of the countdown

## 4.COMMUNICATION AND FAULT

- **Communication status**
  - When communication is abnormal, a prompt will appear
- **Fault state**
  - When a fault occurs, the heater enters the fault lock state
  - Long press confirm button, quit the locking state, heater is closed

### 4.1 IN CONNECTION



- **status**
  - Panel initialization and communication with heater



If the panel fails to communicate with the heater, The panel enters the “No connection” state

### 4.2 NO CONNECTION



- **status**
  - Communication with heater failed
- **Settings**
  - Short press any keys back to initialize



When the "No Connection" state appears, please check the communication cable first.



## 4.3 COMMUNICATION DISCONNECT



- Work Status
  - Communication between panel and heater is disconnected
- Exit
  - Communication recovery automatically exits



- Status
  - Communication between panel and heater is disconnected
- Exit
  - Communication recovery automatically exits



When the "No Connection" state appears, please check the communication cable first

## 4.4 FAULT



- Display
  - Fault state
  - Fault code 11
  - Fault cause (Undervoltage)
- Exit
  - Long press confirm button, exit the fault state



After exiting the fault state, wait until the heater is completely close before restarting the heater. Otherwise the heater may not exit the fail-lock state.

## 5.LED INDICATOR

- LED indicator
  - You can know the current working status by observing the LED indicator
- Display and status
  - The following lists the corresponding states of different LED displays

| Work Status   | LED display          |
|---------------|----------------------|
| Initialize    | Blue light           |
| Disconnect    | Blue light flashing  |
| Operating     | Green light          |
| Shutting Down | Red light            |
| Fault         | Green light flashing |

## 6.REMOTE CONTROL · BLUETOOTH · UPGRADES

- Bluetooth
  - Bluetooth support, can use the (BLF) APP connection control on smart devices
  - To use the Bluetooth function, please refer to the user manual of the (BLF) APP
- Remote Control
  - It supports remote control and can be remotely controlled through the GSM remote control box

## 6.1 REMOTE CONTROL



- **Display**
  - in the process of remote control
- **Function**
  - Remote control box control
  - The default power is P6
- **Exit**
  - Long press the confirm button
  - remote control to close

## 6.2 BLUETOOTH



- **Display**
  - Bluetooth connected
- **Function**
  - On-Line APP control
  - Modifying Bluetooth Name
  - Time Synchronization
  - Check fault
  - Remote upgrade



When the panel is controlled synchronously with the APP, the command is executed with the latest command

## 6.3UPGRADES



- **Display**
  - Upgrading
- **Function**
  - Panel upgrade
  - Heater upgrade
- **Exit**
  - Automatic exit when the upgrade is complete

## 7. INSTALLATION

### ● Installation Notes:

- The control switch must be installed in the vehicle in accordance with the corresponding technical specifications for vehicle control.

### ● Safety Information:

- Find a suitable mounting surface within the driver's field of vision to fix the control switch.
- Do not use high-voltage devices unless the electronic circuit (PCB board) has been disconnected.
- If welding is required on the vehicle, do not connect the DC power supply to the control switch. Welding will cause serious damage to the switch.
- Do not shorten the original control lead wire. When installing this control switch, the vehicle power supply must be turned off.
- This control switch should be installed in the waterproof and moisture-proof location.

## 7.1 INSTALLATION LOCATION

### ● Installation Location:

- The control switch should be installed in the location easy to read and operate
- The opening size of control switch is 16mm × 22mm, refer to "Figure 3"

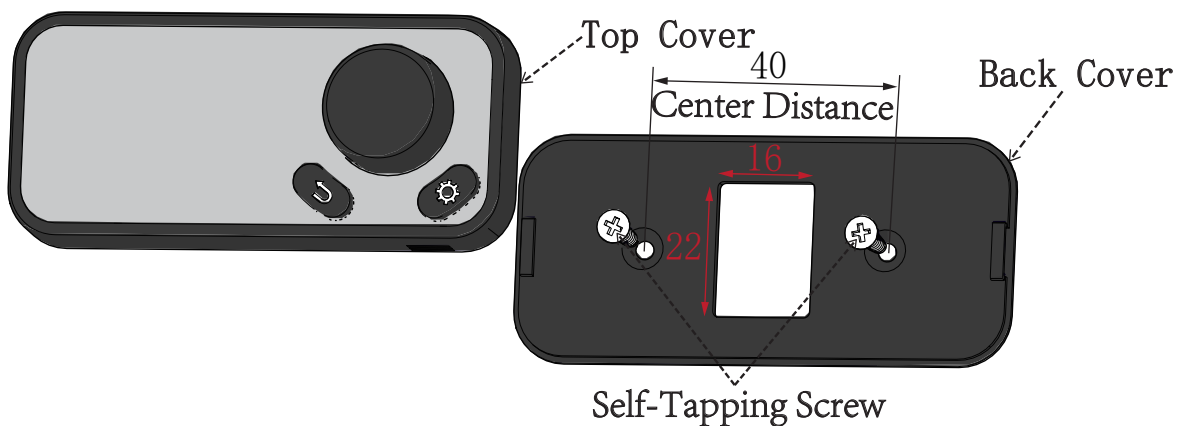

Figure 3

(The dimensions are in millimeters and are not to scale)

## 7.2 INSTALLATION STEPS

### ● Installation steps:

1. Clean the installation opening and surface firstly to ensure that the installation surface is smooth and clean without dust and water mist.
2. Insert the tapping screw into the mounting surface as shown in Figure 3, and fix the back cover on the mounting surface.
- 3 Insert one end of the control switch lead wire into the PCB board terminal as shown in Figure 4, and the other end through the back cover and installation opening as shown in Figure 3.
4. Finally, press the top cover firmly onto the back cover as shown in "Figure 5".

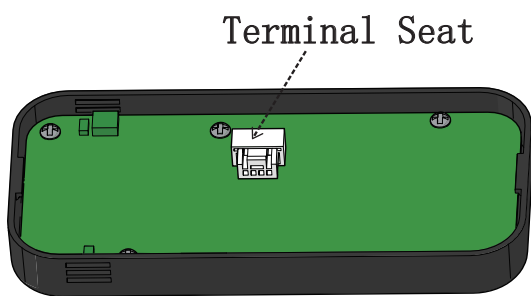

Figure 4

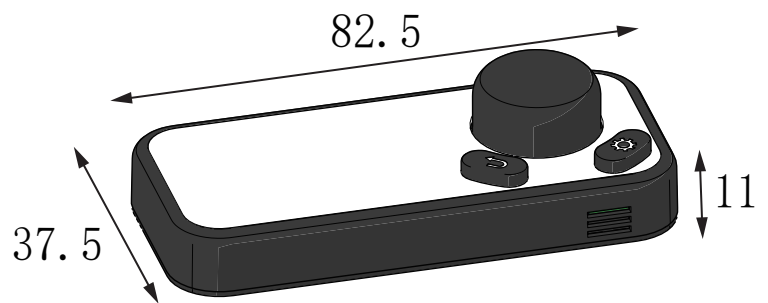

Figure 5



Do not make any tensile stress to the control switch lead wire.



Pull out the the control switch lead wire during the heater working process is forbidden,once the plug at both ends of the lead wire falls off from the control switch or controller, it will cause the heater heating interruption and failure.